

Each Kit Includes



Power Supply



Tape Light



Connection Wire



Connectors



Female Barrel Connector



Male Barrel Connector

Overview of Touch Dimmer Kit Hookup Diagram

Step 1. Connect Power Supply to Touch Dimmer



Step 2. Connect Touch Dimmer to Tape Light



Step 3. Mount Touch Dimmer and Tape Light

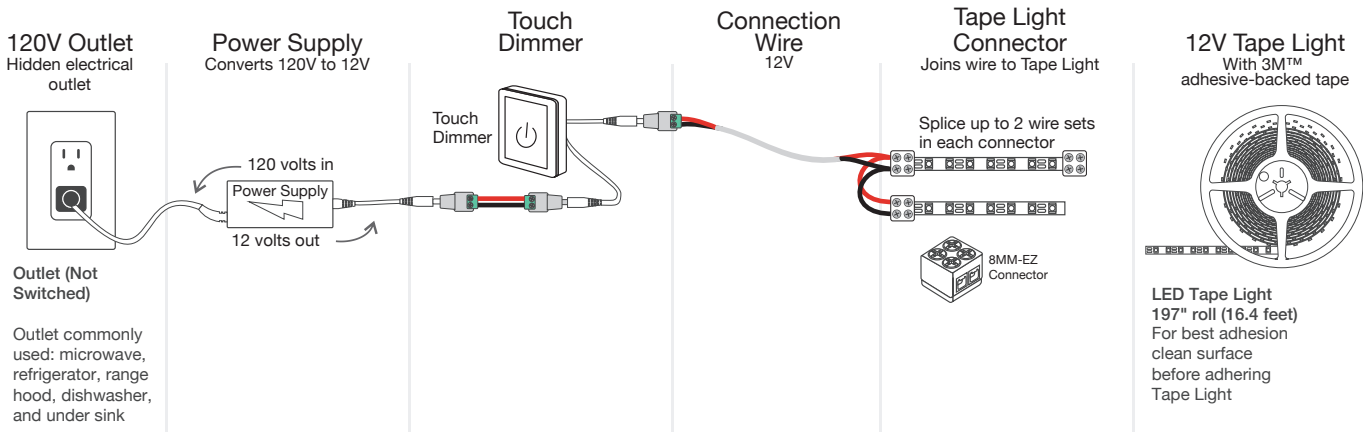

Tools Needed

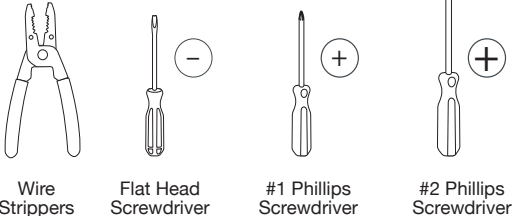

Product Legend

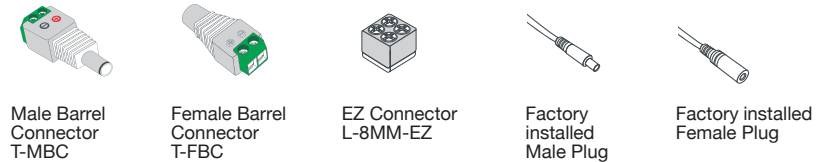

NOTE

- **DO NOT** connect low-voltage LED tape light to high-voltage power.
- Do not over tighten any screws.
- Maintain polarity on all connections, Red to (+) and Black to (-).
- Maximum 32.8 feet of Tape Light can be connected together.
- For shorter lengths of Tape Light, cut straight with scissors at cut marks where a black line runs through 2 solder points
– CUT AT DESIGNATED CUT LINES ONLY

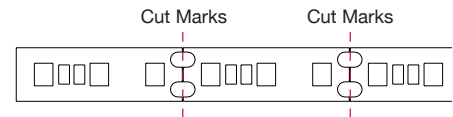

Pre-Installation Testing

1. Completely unroll the LED Tape Light from the reel.

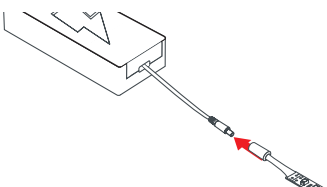

2. Plug-in Power Supply – insert the Male Plug on the Power Supply into the Female Plug on the end of the Tape Light.

3. Turn on 120V AC power to the Power Supply. All LEDs should illuminate.

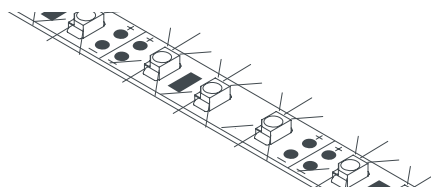

4. Unplug Power Supply – after verifying LED illumination, disconnect LED Tape Light from Power Supply.

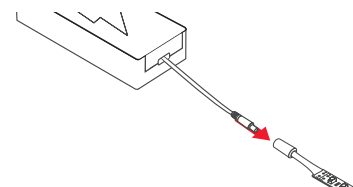

Step 1. Connect Power Supply to Touch Dimmer

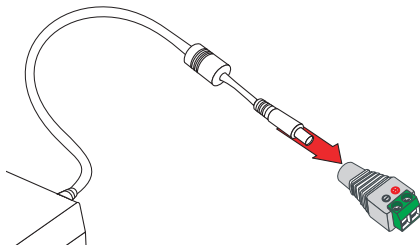

1. Insert the Male Plug on Power Supply into a Female Barrel Connector. Then cut a length of connection wire to run from Power Supply to Touch Dimmer location. Strip 1/4" insulation from both ends of wire, twist each wire, and fold stripped wires in half on both ends.
NOTE: Connection wire can be several inches or feet long depending on location from Power Supply to Touch Dimmer.

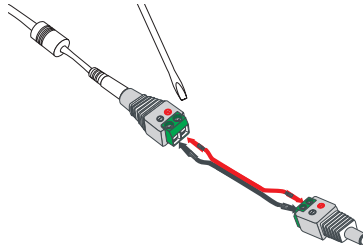

2. Use Flat blade screwdriver to loosen screws on Female Barrel Connector. Insert wires, Red wire to (+), Black wire to (-), and tighten screws. Then use a Flat blade screwdriver to loosen screws on Male Barrel Connector. Insert wires, Red wire to (+), Black wire to (-), and tighten screws.

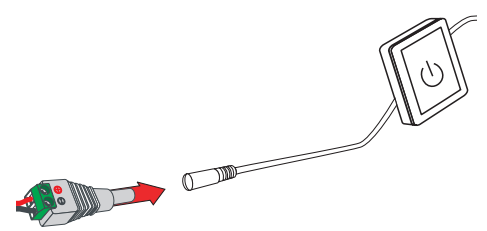

3. Insert the Male Barrel Connector into Female Plug on Touch Dimmer.

Step 2. Connect Touch Dimmer to Tape Light

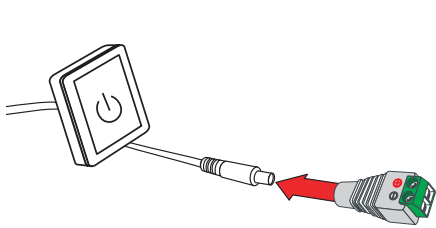

1. Insert the Male Plug on the Touch Dimmer into a Female Barrel Connector. Then cut a length of connection wire to run from Touch Dimmer to Tape Light location. Strip 1/4" insulation from both ends of wire, twist each wire, and fold stripped wires in half on both ends.
NOTE: Connection wire can be several inches or feet long depending on location from Touch Dimmer to Tape Light.

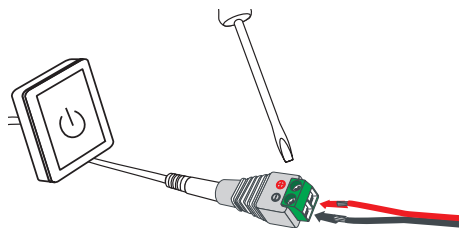

2. Use Flat blade screwdriver to loosen screws on Female Barrel Connector. Insert wires, Red wire to (+), Black wire to (-), and tighten screws.

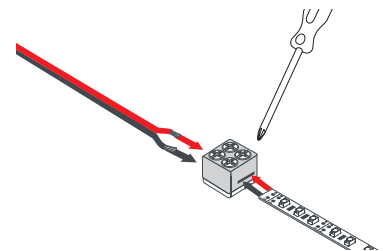

3. Use #1 Phillips to loosen the 4 terminal screws on 8MM-EZ Connector. Peel 1/2" of the adhesive protector from back of LED tape light, insert into connector, evenly tighten screws. Insert wires from Female Barrel Connector into terminals, Red wire to (+) side of tape, Black wire to (-) side of tape; tighten screws.

Step 3. Mount Touch Dimmer and Tape Light

NOTE For fuller countertop coverage, install the Tape Light 1-1/2" from the back of the cabinet face frame or light rail.

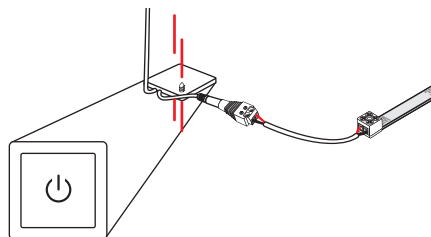

1. Touch Dimmer: Use adhesive pad to hold switch to mounting surface; complete installation by securing with enclosed screws. A quick touch and release will turn the LED Lights on/off. Touch and hold will increase or decrease the light output.

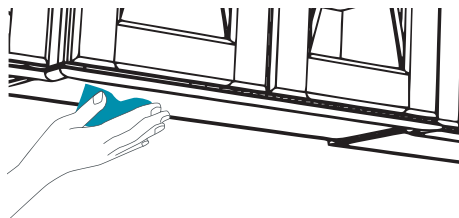

2. LED Tape Light: Make sure mounting surface is clean, dry, oil-free, and dust-free. Using the Adhesion Promoter Wipes will ensure an extra tight bond to surface.

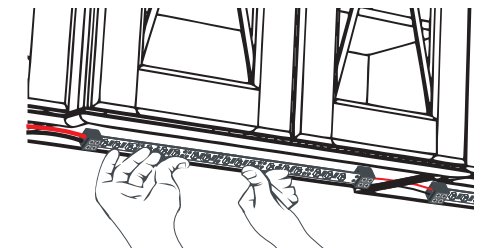

3. Peel the adhesive backing from the Tape Light and mount directly to cleaned surface. Use adhesive pads for securing the connectors to surface.