



# Built-in Power Supply DV Series

Tamper-Resistant Single Receptacle Lighted Power Strip



24-1/2 in. fixture shown in Satin Nickel with Grey receptacles and Grey switch LP24QD8NDGGSN30



Fixture Cross-Section

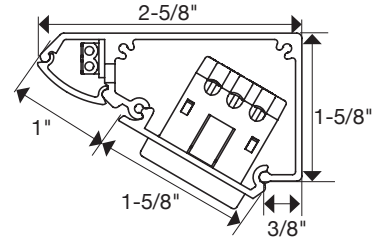

## HIGH LIGHT OUTPUT – 4 WATTS PER FOOT

PART NUMBER	DESCRIPTION	LENGTH	# OF RECEPT.	RECEPT. COLOR	FINISH OPTION	LUMENS Based on 3000K (approx. per fixture)	KELVIN TEMP.
LP10QD2NDColorFinishTemp	10-1/2" DV Series LPS with 1 Single Receptacle. 2 watts per fixture. Built-in power supply. Rocker Switch.	10-1/2"	1	B, G, W	BK, BZ SN, WT	200	2700K (27) 3000K (30) 4000K (40) 5000K (50)
LP12QD4NDColorFinishTemp	12-1/2" DV Series LPS with 2 Single Receptacles. 4 watts per fixture. Built-in power supply. Rocker Switch.	12-1/2"	2	B, G, W	BK, BZ SN, WT	400	2700K (27) 3000K (30) 4000K (40) 5000K (50)
LP18QD6NDColorFinishTemp	18-1/2" DV Series LPS with 2 Single Receptacles. 6 watts per fixture. Built-in power supply. Rocker Switch.	18-1/2"	2	B, G, W	BK, BZ SN, WT	600	2700K (27) 3000K (30) 4000K (40) 5000K (50)
LP24QD8NDColorFinishTemp	24-1/2" DV Series LPS with 4 Single Receptacles. 8 watts per fixture. Built-in power supply. Rocker Switch.	24-1/2"	4	B, G, W	BK, BZ SN, WT	800	2700K (27) 3000K (30) 4000K (40) 5000K (50)
LP30QD10NDColorFinishTemp	30-1/2" DV Series LPS with 4 Single Receptacles. 10 watts per fixture. Built-in power supply. Rocker Switch.	30-1/2"	4	B, G, W	BK, BZ SN, WT	1000	2700K (27) 3000K (30) 4000K (40) 5000K (50)
LP36QD12NDColorFinishTemp	36-1/2" DV Series LPS with 4 Single Receptacles. 12 watts per fixture. Built-in power supply. Rocker Switch.	36-1/2"	4	B, G, W	BK, BZ SN, WT	1200	2700K (27) 3000K (30) 4000K (40) 5000K (50)

Blue indicates customer choice. Color indicates receptacle color, Finish indicates fixture finish color, and Temp indicates Kelvin Temperature

## TECHNICAL INFORMATION

Series	LPS DV Series
Input Voltage	120 volts
Amps	15 amp
Color Temperature (Kelvin)	Warm white 2700K (27) Soft white 3000K (30) Cool white 4000K (40) Daylight white 5000K (50)
CRI (Color Rendering Index)	90+
Wattage	1/4 watt LEDs
Lumens	400 lumens per foot
Max Run	Refer to power supply specs
Cuttable	No
IP Rating	----
Dimmable	5%-100%
Rating	cULus Listed
Rated Life	50,000 hrs
LED Beam Angle	120°
LED Spacing	1/4"
LED Board	6" or 12"
Mounting	Wood Screws and Wall Anchors (included)
Wiring	12 gauge Romex for receptacles 18-20 gauge wire for LEDs
Environment	Dry locations
Construction Material	Powder coated aluminum, IR Acrylic (lens)
Warranty	5 years

## FEATURES

- Low profile – 1-5/8"
- Built-in power supply – direct replacement for a stand-alone fluorescent light
- High LED diode density boards creates No Dot effect
- 120 volt fixture
- 15 amp tamper-resistant single receptacles
- 5-year limited warranty
- Available in standard lengths only
- Designed for indoor application
- Simple to install fully assembled fixture with wood screws and wall anchors (included with fixture)
- Dimming requires a dedicated circuit for the lighting

## APPLICATIONS

- Kitchens
- Bathrooms
- Offices and computer labs
- Islands
- Shops and garages

## COMPATIBLE SWITCH

PART NUMBER	DESCRIPTION	DIMENSIONS
DVELV-300P-Color	300W Diva slide dimmer.	4.69" x 2.94" x 1.31"

## RECEPTACLE COLOR & FINISH OPTIONS

Receptacle Colors				
	Black (B)	Black (B)	Grey (G)	White (W)
Finish Options				
	Black (BK)	Bronze (BZ)	Satin Nickel (SN)	White (WT)

**WITH Built-in power supply and switch – High light output – 4 watts per foot**

**36-1/2" Fixture – LP36QD12NDColorFinishTemp**

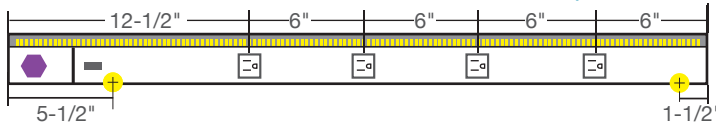

**30-1/2" Fixture – LP30QD10NDColorFinishTemp**

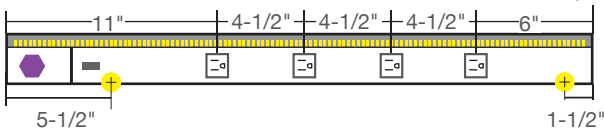

**24-1/2" Fixture – LP24QD8NDColorFinishTemp**

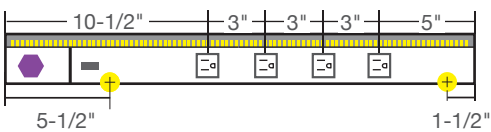

**18-1/2" Fixture – LP18QD6NDColorFinishTemp**

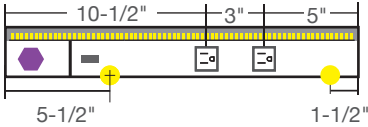

**12-1/2" Fixture – LP12QD4NDColorFinishTemp**

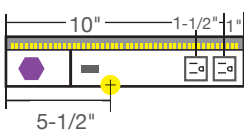



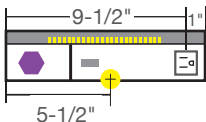

**10-1/2" Fixture – LP10QDV2ColorFinishTemp**



NOTE: 6" LED board is mounted in center of 10-1/2" fixture

**LEGEND**

-  = 15 amp receptacle available in Black (B), Grey (G), or White (W)
-  = Switch (Available in Black, Grey, or White – 4-1/2" from left side)
-  = Divider Plate (Low Voltage)
-  = Power Supply
-  = Knock-out (1-1/2" from right side – 5-1/2" from left side) located on back frame

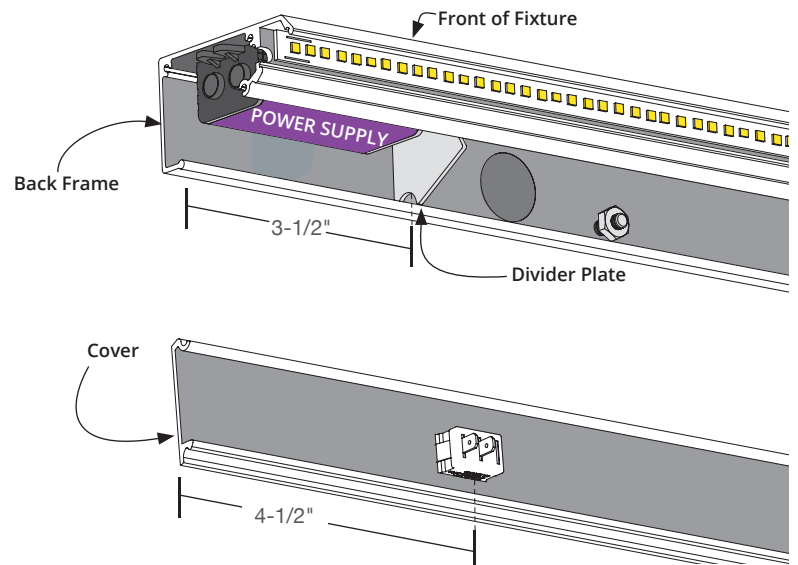

24-1/2 in. fixture shown in Satin Nickel with Grey receptacles and Grey switch  
LP24QD8NDGSN30



Fixture Cross-Section

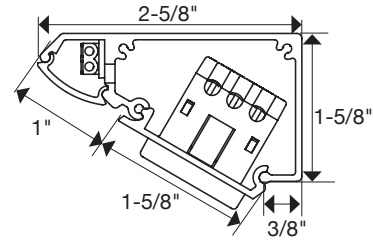

### HIGHER LIGHT OUTPUT – 6 WATTS PER FOOT

PART NUMBER	DESCRIPTION	LENGTH	# OF RECEPT.	RECEPT. COLOR	FINISH OPTION	LUMENS Based on 3000K (approx. per fixture)	KELVIN TEMP.
LP10HR3NDColorFinishTemp	10-1/2" DV Series LPS with 1 Single Receptacle. 3 watts per fixture. External power supply required.	10-1/2"	1	B, G, W	BK, BZ SN, WT	300	2700K (27) 3000K (30) 4000K (40) 5000K (50)
LP12HR6NDColorFinishTemp	12-1/2" DV Series LPS with 2 Single Receptacles. 6 watts per fixture. External power supply required.	12-1/2"	2	B, G, W	BK, BZ SN, WT	600	2700K (27) 3000K (30) 4000K (40) 5000K (50)
LP18HR9NDColorFinishTemp	18-1/2" DV Series LPS with 2 Single Receptacles. 9 watts per fixture. External power supply required.	18-1/2"	2	B, G, W	BK, BZ SN, WT	900	2700K (27) 3000K (30) 4000K (40) 5000K (50)
LP24HR12NDColorFinishTemp	24-1/2" DV Series LPS with 4 Single Receptacles. 12 watts per fixture. External power supply required.	24-1/2"	4	B, G, W	BK, BZ SN, WT	1200	2700K (27) 3000K (30) 4000K (40) 5000K (50)
LP30HR15NDColorFinishTemp	30-1/2" DV Series LPS with 4 Single Receptacles. 15 watts per fixture. External power supply required.	30-1/2"	4	B, G, W	BK, BZ SN, WT	1500	2700K (27) 3000K (30) 4000K (40) 5000K (50)
LP36HR18NDColorFinishTemp	36-1/2" DV Series LPS with 4 Single Receptacles. 18 watts per fixture. External power supply required.	36-1/2"	4	B, G, W	BK, BZ SN, WT	1800	2700K (27) 3000K (30) 4000K (40) 5000K (50)
LP42HR21NDColorFinishTemp	42-1/2" DV Series LPS with 5 Single Receptacles. 21 watts per fixture. External power supply required.	42-1/2"	5	B, G, W	BK, BZ SN, WT	2100	2700K (27) 3000K (30) 4000K (40) 5000K (50)
LP48HR24NDColorFinishTemp	48-1/2" DV Series LPS with 5 Single Receptacles. 24 watts per fixture. External power supply required.	48-1/2"	5	B, G, W	BK, BZ SN, WT	2400	2700K (27) 3000K (30) 4000K (40) 5000K (50)
LP60HR30NDColorFinishTemp	60-1/2" DV Series LPS with 7 Single Receptacles. 30 watts per fixture. External power supply required.	60-1/2"	7	B, G, W	BK, BZ SN, WT	3000	2700K (27) 3000K (30) 4000K (40) 5000K (50)
LP72HR36NDColorFinishTemp	72-1/2" DV Series LPS with 8 Single Receptacles. 36 watts per fixture. External power supply required.	72-1/2"	8	B, G, W	BK, BZ SN, WT	3600	2700K (27) 3000K (30) 4000K (40) 5000K (50)

Blue indicates customer choice. Color indicates receptacle color, Finish indicates fixture finish color, and Temp indicates Kelvin Temperature

### RECEPTACLE COLOR & FINISH OPTIONS

Receptacle Colors				
	Black (B)	Black (B)	Grey (G)	White (W)
Finish Options				
	Black (BK)	Bronze (BZ)	Satin Nickel (SN)	White (WT)

### FEATURES

- Low profile – 1-5/8"
- Remote power supply (order separately)
- High LED diode density boards creates No Dot effect
- 120 volt fixture
- 15 amp tamper-resistant single receptacles
- 5-year limited warranty
- Custom options available – custom lengths and receptacle placement. Optional rocker switch/ placement available
- Designed for indoor application
- Simple to install fully assembled fixture with wood screws and wall anchors (included with fixture)
- Dimming requires a dedicated circuit for the lighting

### APPLICATIONS

- Kitchens
- Bathrooms
- Offices and computer labs
- Islands
- Shops and garages

### TECHNICAL INFORMATION

<b>Series</b>	LPS RM Series
<b>Input Voltage</b>	120 volts
<b>Amps</b>	15 amp
<b>Color Temperature</b> (Kelvin)	Warm white 2700K (27) Soft white 3000K (30) Cool white 4000K (40) Daylight white 5000K (50)
<b>CRI</b> (Color Rendering Index)	90+
<b>Wattage</b>	1/2 watt LEDs
<b>Lumens</b>	600 lumens per foot
<b>Max Run</b>	Refer to power supply specs
<b>Cuttable</b>	No
<b>IP Rating</b>	----
<b>Dimmable</b>	5% – 100%
<b>Rating</b>	cULus Listed
<b>Rated Life</b>	50,000 hrs
<b>LED Beam Angle</b>	120°
<b>LED Spacing</b>	1/4"
<b>LED Board</b>	6" or 12"
<b>Mounting</b>	Wood Screws and Wall Anchors (included)
<b>Wiring</b>	12 gauge Romex for receptacles 18-20 gauge wire for LEDs
<b>Environment</b>	Dry locations
<b>Construction Material</b>	Powder coated aluminum, IR Acrylic (lens)
<b>Warranty</b>	5 years

### COMPATIBLE POWER SUPPLIES

PART NUMBER	DESCRIPTION	DIMENSIONS
<b>T-12W-12V-PI</b>	12 watt AC/DC 2 prong plug-in, 12 volt DC 1 AMP.	2-15/16" x 1-3/16" x 1-13/16"
<b>T-24W-12V-PI</b>	24 watt AC/DC 2 prong plug-in, 12 volt DC 2 AMP.	3-11/16" x 1-7/8" x 1-5/16"
<b>T-36W-12V-PI</b>	36 watt AC/DC 2 prong plug-in, 12 volt DC 3 AMP	3-3/4" x 2" x 1-5/16"
<b>T-60W-12V-PI</b>	60 watt AC/DC 2 prong plug-in, 12 volt DC 5 AMP	5-1/8" x 2-1/16" x 1-1/4"
<b>T-96W-12V-PI</b>	96 watt AC/DC 3 prong plug-in, 12 volt DC 8 AMP.	5-1/2" x 2-3/8" x 1-3/8"
<b>T-120W-12V-PI</b>	120 watt AC/DC 3 prong plug-in, 12 volt DC 10 AMP	6-3/8" x 2-11/16" x 1-1/4"
<b>T-60W-12-WP-HW</b>	60 watt, 12 volt IP67 rated waterproof LED hardwired	6-1/2" x 1-5/8" x 1-1/4"
<b>T-150W-12-WP-HW</b>	150 watt, 12 volt IP67 rated waterproof LED hardwired.	7-3/8" x 2-3/8" x 1-1/2"
<b>T-DT24W-12V-HW</b>	24 watt 12 volt DC dimmable class 2 LED hardwired.	13-3/4" x 3" x 1-5/8"
<b>T-DT48W-12V-HW</b>	48 watt 12 volt DC dimmable class 2 LED hardwired	13-3/4" x 3" x 1-5/8"
<b>T-DT60W-12V-HW</b>	60 watt 12 volt DC dimmable class 2 LED hardwired	13-3/4" x 3" x 1-5/8"
<b>T-DT120W-12V-HW</b>	120 watt 12 volt DC dimmable LED hardwired	15" x 3-1/8" x 2-1/2"
<b>T-WAV-60W-PSR</b>	60 watt AC/DC 2 prong plug-in, 12 volt DC 5 AMP with built in smart LED receiver	7-1/4" x 2-7/8" x 1-5/8"

### COMPATIBLE DIMMING SYSTEMS / SWITCHES

PART NUMBER	DESCRIPTION	DIMENSIONS
<b>T-Q-1Z-WC-RF-Color</b>	Uno 1-Zone LED controller. On / Off / Dimmer. Use with LED Receiver.	2-5/8" x 1-5/16" x 3/8"
<b>T-Q-2Z-WC-RF-Color</b>	Duo 2-Zone LED controller. On / Off / Dimmer. Use with LED Receiver.	2-5/8" x 1-5/16" x 3/8"
<b>T-Q-4Z-WC-RF-Color</b>	Quattro 4-Zone LED controller. On / Off / Dimmer. Use with LED Receiver.	2-5/8" x 1-5/16" x 3/8"
<b>T-TWAV-WR-120</b>	WAV 120 watt smart LED Receiver. Use with a Wireless Controller	4-1/4" x 2-1/4" x 3/8"
<b>T-Q-WR96</b>	96 watt LED Receiver. Use with a Wireless Controller	3-3/8" x 1-1/2" x 13/16"
<b>T-Q-WR240</b>	240 watt LED Receiver. Use with a Wireless Controller.	6-7/16" x 1-7/8" x 15/16"
<b>T-DSS-30W-IR</b>	Infrared (IR) door sensor switch.	3/8" x 1" x 1-1/4"
<b>T-2HDSS-30W-IR</b>	Infrared (IR) door sensor switch <b>with two heads</b>	3/8" x 1" x 1-1/4"
<b>T-MSS-60W</b>	Motion sensor switch	1/2" x 2-1/4"
<b>T-PSS-60W-IR</b>	Infrared (IR) sensor proximity switch.	2-1/4" x 3/8"
<b>T-TDS-60W</b>	LED touch dimmer.	3/8" x 2" x 2"
<b>T-WSS-60W-IR</b>	Infrared (IR) wave sensor switch	2-1/4" x 3/8"
<b>DVLV-600P-Color</b>	600W Diva slide dimmer.	4.69" x 2.94" x 1.31"
<b>T-RS-BK</b>	On / off round switch	15/16"
<b>T-WAV-AC120V-R</b>	WAV 120 volt AC/AC Smart Receiver	1-3/4" x 1-3/4" x 13/16"

## USING EXTERNAL power supply – Higher light output – 6 watts per foot

### 72-1/2" Fixture – LP72HR36NDColorFinishTemp

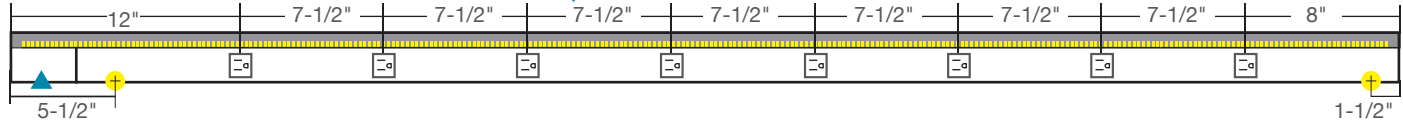

### 60-1/2" Fixture – LP60HR30NDColorFinishTemp

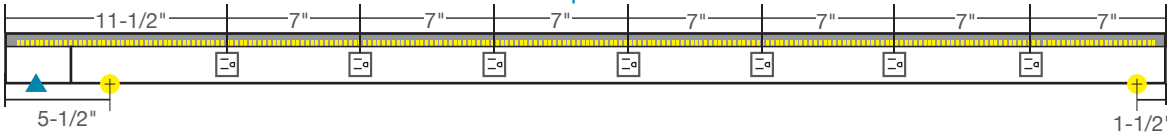

### 48-1/2" Fixture – LP48HR24NDColorFinishTemp

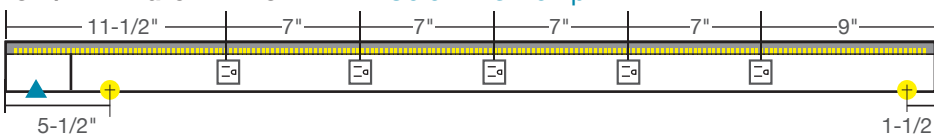

### 42-12" Fixture – LP42HR21NDColorFinishTemp

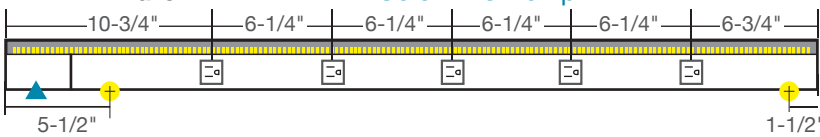

### 36-1/2" Fixture – LP36HR18NDColorFinishTemp

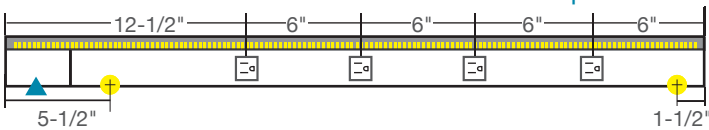

### 30-1/2" Fixture – LP30HR15NDColorFinishTemp

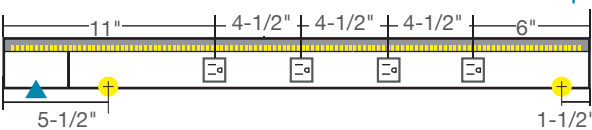

### 24-1/2" Fixture – LP24HR12NDColorFinishTemp

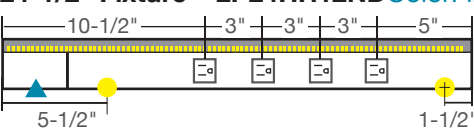

### 18-1/2" Fixture – LP18HR9NDColorFinishTemp

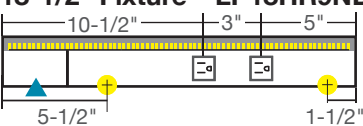

### 12-1/2" Fixture – LP12HRM6NDColorFinishTemp

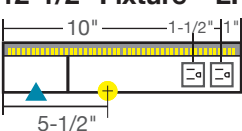

### 10-1/2" Fixture – LP10HR3NDColorFinishTemp

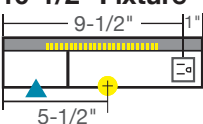

NOTE: 6" LED board is mounted in center of 10-1/2" fixture

## LEGEND

= 15 amp receptacle available in Black (B), Grey (G), or White (W)

= Divider Plate (Low Voltage)

= Knock-out (1-1/2" from right side – 5-1/2" from left side) located on back frame

= Low Voltage Entry (1-1/2" from left side) located on back frame

## CUSTOM OPTIONS/DETAILS

- Custom lengths from 10-1/2" – 92"
- 120 volt integral switch (available in Black, Grey, or White)
- Custom receptacle/switch placement
- Receptacles must be a minimum of 1-1/2" apart (on center)
- Receptacles must be a minimum of 1" from right side & 5-1/2" from left side.  
**Knockout cannot be behind device.**
- Custom charges may apply — Call Design Services at 866-848-9094 for a quote, lead time, and assistance with your custom order

